

DIGITAL MULTIMETER

USERS MANUAL

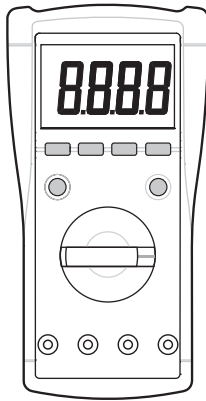

Read this manual thoroughly before use



WARRANTY

This instrument is warranted to be free from defects in material and workmanship for a period of one year. Any instrument found defective within one year from the delivery date and returned to the factory with transportation charges prepaid, will be repaired, adjusted, or replaced at no charge to the original purchaser. This warranty does not cover expandable items such as battery or fuse. If the defect has been caused by a misuse or abnormal operating conditions, the repair will be billed at a nominal cost.

SAFETY INFORMATION



This meter has been designed according to IEC-61010 concerning electronic measuring instruments with a measurement category (CAT III 600V) and pollution degree 2.

Warning

To avoid possible electric shock or personal injury, follow these guidelines:









- a. Do not use the meter if it is damaged. Before you use the meter, inspect the case. Pay particular attention to the insulation surrounding the connectors.
- b. Inspect the test leads for damaged insulation or exposed

- metal. Check the test leads for continuity. Replace damaged test leads before you use the meter.
- c. Do not use the meter if it operates abnormally. Protection may be impaired. When in doubt, have the meter serviced.
- d. Do not operate the meter around explosive gas, vapor, or dust.
- e. Do not apply more than the rated voltage, as marked on the meter, between terminals or between any terminal and earth ground.
- f. Before use, verify the meter's operation by measuring a known voltage.
- g. When measuring current, turn off circuit power before connecting the meter in the circuit. Remember to place the meter in series with the circuit.
- h. When servicing the meter, use only specified replacement parts.
 - i. Use caution when working above 30V ac rms, 42V peak, or 60V dc. Such voltages pose a shock hazard.
 - j. When using the probes, keep your fingers behind the finger guards on the probes.
 - k. When making connections, connect the common test lead before you connect the live test lead. When you disconnect test leads, disconnect the live test lead first.
- l. Remove the test leads from the meter before you open the battery cover or the case.

- m. Do not operate the meter with the battery cover or portions of the case removed or loosened.
- n. To avoid false readings, which could lead to possible electric shock or personal injury, replace the battery as soon as the low battery indicator ("  ") appears.
- o. Do not use the meter in a manner not specified by this manual or the safety features of the meter may be impaired.
- p. When in Relative mode (the symbol "  " is displayed) or in Data Hold mode(the symbol "  " is displayed), caution must be used because hazardous voltage may be present.
- q. Do not touch any naked conductor with hand or skin. Do not ground yourself.
- r. Do not operate this meter if your hand or the meter is wet.
- s. Adhere to local and national safety codes. Use Individual protective equipment to prevent shock and arc blast injury when working in an area where hazardous live conductors are exposed.
- t. Remaining endangerment:
When an input terminal is connected to dangerous live potential it is to be noted that this potential at all other terminals can occur!
- u. CAT III - Measurement category III is for measurements performed in the building installation.

3

Symbol

-  Alternating Current
-  Direct Current
-  DC or AC
-  Caution, risk of danger, refer to the operating manual before use.
-  Caution, risk of electric shock.
-  Earth (ground) Terminal
-  Fuse
-  Conforms to European Union directives
-  The equipment is protected throughout by double insulation or reinforced insulation.

GENERAL DESCRIPTION

This meter is a compact 3 3/4 digits digital multimeter for measuring DC and AC voltage, DC and AC current, resistance, capacitance, frequency, diode, continuity and duty cycle. It features polarity indication, data hold, overrange indication, automatic power-off, and so on. It is easy to operate and is an ideal measurement tool.

5

Examples are measurements on distribution boards, circuit breakers, wiring, including cables, bus-bars, junction boxes, switches, socket-outlets in the fixed installation, and equipment for industrial use and some other equipment, for example, stationary motors with permanent connection to fixed installation. Do not use the meter for measurements within Measurement Categories IV.

Caution

To avoid possible damage to the meter or to the equipment under test, follow these guidelines:

- a. Disconnect circuit power and discharge all capacitors before testing resistance, diode, capacitor and continuity.
- b. Use the proper terminals, function, and range for your measurements.
- c. Before measuring current, check the meter's fuses and turn off the power to the circuit before connecting the meter to the circuit.
- d. Before rotating the range switch to change functions, disconnect test leads from the circuit under test.
- e. Remove test leads from the meter before opening the meter case or the battery cover.

4

STRUCTURE

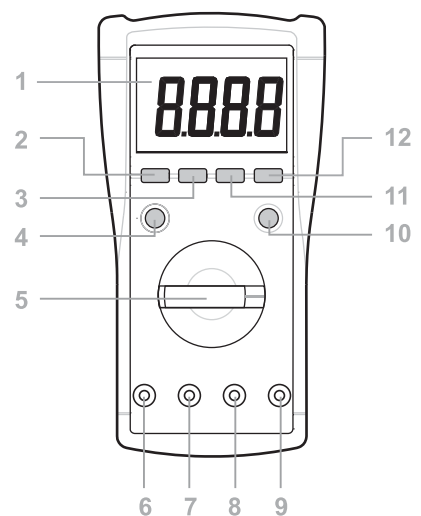

1. Display

3 3/4-digit LCD, with a max. reading of 3999

2. " Hz % " Button

When the function/range switch is in " Hz/% " position, pressing this button switches the meter between frequency and duty cycle measurements.

6

3. " RANGE " Button

It can be used to switch the meter between autorange mode and manual range mode.
It can also be used to select desired manual range.

4. " S " Button

In current measurement functions, pressing this button switches the meter between DC current and AC current measurements.

When the Function/Range switch is in " \rightarrow/\rightarrow " position, pressing this button switches the meter between diode and continuity measurements.

5. Function / Range switch

It can be used to select the desired function and range as well as to turn on or off the meter.

6. " 10A " jack

Plug-in connector for the red test lead for current measurements (400mA ~ 10A).

7. " μ A/mA " jack

Plug-in connector for the red test lead for the current measurements < 400mA.

8. "COM" jack

Plug-in connector for the black test lead for all measurements.

9. "V Ω Hz \rightarrow " jack

Plug-in connector for the red test lead for all measurements except current measurements.

10. " \star " button

Press this button to turn on the backlight. Press the button again to turn off the backlight.

11. " REL " button

Used to select Relative mode.

12. " HOLD " button

Used to select Data Hold mode.

READING THE LCD

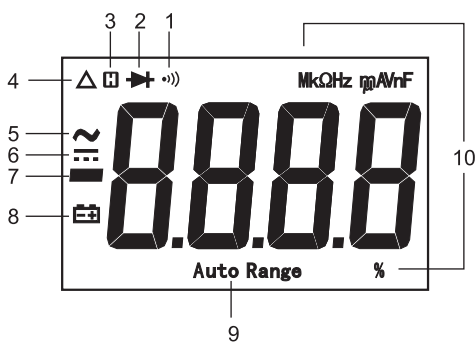

Symbol Meaning

1. \parallel ---- Continuity test is selected
2. \rightarrow ---- Diode test is selected
3. \square ---- Data Hold is enabled
4. Δ ---- Relative mode is active
5. \sim ---- AC
6. \equiv ---- DC
7. — ---- Negative sign
8. — ---- Battery is low and should be replaced immediately.
9. Auto Range ---- Autorange mode is selected

10. Units on the LCD

mV, V	Voltage unit mV: Millivolt ; V: Volt; $1V=10^3mV$
μ A, mA, A	Current unit μ A: Microamp; mA: Milliamp; A: Ampere; $1A=10^3mA=10^6\mu A$
Ω , k Ω , M Ω	Resistance unit Ω : Ohm; k Ω : Kilohm; M Ω : Megohm; $1M\Omega=10^3k\Omega=10^6\Omega$
nF, μ F	Capacitance unit nF: Nanofarad; μ F: Microfarad; $1F=10^6\mu F=10^9nF=10^{12}pF$
Hz, kHz, MHz	Frequency unit Hz:Hertz; kHz:Kilohertz; MHz:Megahertz; $1MHz=10^3kHz=10^6Hz$
%	Unit of duty cycle %: Percent

GENERAL SPECIFICATION

Display: 3 3/4-digit LCD, with a max. reading 3999
Overrange Indication: " OL " shown on the LCD
Negative Polarity Indication: " - " displayed on the LCD automatically
Sampling Rate: 2~3 times/sec
Operating Environment: 0°C ~ 40°C, < 75%RH
Temperature Coefficient:
 0.2 x (specified accuracy)/°C (<18°C or >28°C)
Storage Environment: -10°C ~ 50°C, < 85%RH
Operating Altitude: 0 to 2000 meters
Battery: 9V, 6F22 or equivalent
Low Battery Indication: "  " shown on the LCD
Size: 188X96X58mm
Weight: about 430g (including battery)

11

SPECIFICATIONS

Accuracy is specified for a period of one year after calibration and at 18°C to 28°C, with relative humidity < 75%.

Except where specified specially, accuracy is specified from 8 % to 100% of range.

DC Voltage

Range	Resolution	Accuracy
400mV	0.1mV	±(1.0%+5)
4V	0.001V	±(0.8%+3)
40V	0.01V	
400V	0.1V	
600V	1V	±(1%+5)

Input Impedance: the 400mV range: > 1000MΩ
 the other ranges: 10MΩ

Overload Protection: 600V DC/AC rms

12

AC Voltage

Range	Resolution	Accuracy
4V	0.001V	±(1.0%+5)
40V	0.01V	
400V	0.1V	
600V	1V	±(1.2%+5)

Input Impedance: 10MΩ

Frequency Range: 40Hz ~ 400Hz

Response: Average, calibrated in rms of sine wave

Overload Protection: 600V DC/AC rms

Note: The 10A range is specified from 20% to 100% of range.

AC Current

Range	Resolution	Accuracy
400μA	0.1μA	±(1.5%+5)
4000μA	1μA	
40mA	0.01mA	±(1.8%+5)
400mA	0.1mA	
4A	0.001A	±(2.0%+5)
10A	0.01A	±(2.5%+10)

Overload Protection: Fuse 1: F 400mA/690V
 Fuse 2: F 10A/690V

Max. Input Current: 10A (For inputs > 2A : measurement duration < 10 secs, interval >15 minutes)

Frequency Range: 40Hz ~ 400Hz

Response: Average, calibrated in rms of sine wave

Max. Voltage Drop: 400mV

Note: The 10A range is specified from 20% to 100% of range.

DC Current

Range	Resolution	Accuracy
400μA	0.1μA	±(1.2%+3)
4000μA	1μA	
40mA	0.01mA	±(1.5%+3)
400mA	0.1mA	
4A	0.001A	±(1.8%+3)
10A	0.01A	±(2.0%+5)

Overload Protection: Fuse 1: F 400mA/690V

Fuse 2: F 10A/690V

Max. Input Current: 10A (For inputs > 2A : measurement duration < 10 secs, interval >15 minutes)

Max. Measurement Voltage Drop: 400mV

13

14

Frequency

Range	Resolution	Accuracy
10Hz	0.01Hz	$\pm(1.0\%+3)$
100Hz	0.1Hz	$\pm(0.8\%+3)$
1kHz	0.001kHz	
10kHz	0.01kHz	
100kHz	0.1kHz	

Input Voltage: 1V rms ~ 20V rms

Duty Cycle

Range	Resolution	Accuracy
5%~99%	0.1%	1Hz~10kHz: $\pm(2\%+5)$
		>10kHz: not specified

Input Voltage: 3Vp-p ~ 10Vp-p

Overload Protection: 600V DC/AC rms

15

Resistance

Range	Resolution	Accuracy
400Ω	0.1Ω	$\pm(1.0\%+5)$
4kΩ	0.001kΩ	$\pm(1.0\%+3)$
40kΩ	0.01kΩ	
400kΩ	0.1kΩ	
4MΩ	0.001MΩ	
40MΩ	0.01MΩ	$\pm(1.8\%+5)$

Capacitance

Range	Resolution	Accuracy
40nF	0.01nF	$\pm(4\%+20)$ (REL)
400nF	0.1nF	$\pm(3\%+5)$ (REL)
4μF	0.001μF	$\pm(4\%+5)$
40μF	0.01μF	
100μF	0.1μF	$\pm(8\%+5)$

For the ranges $\leq 400\text{nF}$, use Relative mode (REL) to subtract the stray capacitance of the test leads and the Meter.

For the range of 100μF, wait about 30 secs for the reading to settle.

16

Diode Test

Range	Introduction	Remark
2V	The approximate forward voltage drop of the diode will be displayed. If the voltage drop is more than 2V, the display shows the overrange indicator " OL ".	Open Circuit Voltage: about 2V Short Circuit Current : < 0.6mA

Continuity Test

Range	Introduction	Remark
•1))	The built-in buzzer will sound if the resistance is less than about 30Ω. The buzzer will not sound if the resistance is more than 150Ω.	Open Circuit Voltage: about 0.45V

17

OPERATION INSTRUCTION

Using Relative Mode

Selecting Relative mode causes the meter to store the present reading as a reference for subsequent measurements and zero the display.

1. Press the **REL** button, the meter enters the Relative mode and store the present reading as a reference for subsequent measurements, and "Δ" appears as an indicator. The display reads zero.
2. When you perform a new measurement, the display shows the difference between the reference and the new measurement.
3. Press the **REL** button again, the meter exits the Relative mode.

Note:

Relative mode is available only in voltage, current, capacitance and resistance measurements.

Manual Ranging and Autoranging

The meter defaults to autorange mode in measurement functions which have both autorange mode and manual range mode. When the meter is in autorange mode,

18

" **Auto Range** " is displayed.

1. Press the **RANGE** button to enter the manual range mode, the symbol " **Auto Range** " disappears. Each press of the **RANGE** button increases the range. When the highest range is reached, the meter wraps to the lowest range.
2. To exit the manual range mode, press and hold down the **RANGE** button for about 2 seconds. The meter returns to the autorange mode and " **Auto Range** " is displayed.

Data Hold Mode

Press the **HOLD** button to hold the present reading on the display, the symbol " **H** " appears on the LCD as an indicator. To exit the Data Hold mode, press the button again. " **H** " disappears.

Built- In Buzzer

1. When you press a button, the built-in buzzer will sound a beep if the press is effective.
2. The buzzer will sound several short beeps about 1 minute before the meter turns off automatically and sound 1 long beep before the meter turns off automatically.

19

Measuring DC or AC Voltage

1. Connect the black test lead to the " **COM** " jack and the red test lead to the " **VΩHz** " jack.
2. Set the range switch to the **V** position for dc voltage measurement or to the **V~** position for ac voltage measurement.
3. Select autorange mode or manual range mode with the " **RANGE** " button.
If you use manual range mode and don't know the magnitude of the voltage to be measured beforehand, select the highest range and then reduce it range by range until satisfactory resolution is obtained.
4. Connect the test leads across the source or circuit to be measured.
5. Read the reading on the display. For DC voltage measurements, the polarity of red lead connection will be indicated as well.

Note:

To avoid electric shock to you or damages to the meter, do not attempt to measure dc voltage higher than 600V or ac voltage higher than 600V rms.

21

3. The buzzer will sound and the display will show " **OL** " in one of the following conditions:
 - a. The AC voltage under measurement is more than about 600V ac when the meter is in the highest AC voltage range.
 - b. The DC voltage under measurement is more than about 600V dc when the meter is in the highest DC voltage range.
 - c. The DC current under measurement is more than about 10A dc when the meter is in the highest DC current range.
 - d. The AC current under measurement is more than about 10A ac when the meter is in the highest AC current range.

20

Measuring DC or AC Current

1. Connect the black test lead to the " **COM** " jack. If the current to be measured is less than 400mA, connect the red test lead to the " **μA/mA** " jack. If the current is between 400mA and 10A, connect the red test lead to the " **10A** " jack instead.
2. Set the range switch to desired **A**, **mA** or **μA** position.
3. Press the " **S** " button to select DC current or AC current measurement. The display shows the corresponding symbol.
4. Turn off power to the circuit which you want to measure. Discharge all highvoltage capacitors.
5. Break the circuit path to be measured, connect the test leads in series with the circuit.
6. Turn on power to the circuit, then read the display. For DC current measurements, the polarity of the red test lead connection will be indicated as well.

Note:

If the magnitude of the current to be measured is not known beforehand, select the highest range and then reduce it range by range until satisfactory resolution is obtained.

22

Measuring Resistance

1. Connect the black test lead to the " **COM** " jack and the red test lead to the " **VΩHz** " jack. (Note: The polarity of the red lead is positive " + ")
2. Set the range switch to Ω range.
3. Connect test leads across the load to be measured.
4. Read the reading on the display.

Note :

1. For measurements $> 1M\Omega$, the meter may take a few seconds to stabilize reading. This is normal for high resistance measurements.
2. When the input is not connected, i.e. at open circuit, " OL " will be displayed as overrange indication.
3. To avoid electric shock to you or damage to the meter, disconnect circuit power and discharge all capacitors before measuring resistance.

Continuity Test

1. Connect the black test lead to the " **COM** " jack and the red test lead to the " **VΩHz** " jack. (Note:The polarity of the red lead is positive "+")
2. Set the range switch to $\rightarrow+/•$ position, then press the " **S** " button until the symbol " $•$ " appears on the display.

23

Measuring Capacitance

1. Connect the black test lead to the " **COM** " jack and the red test lead to the " **VΩHz** " jack.
2. Set the range switch to $\rightarrow C$ position.
3. If the display doesn't read zero, press the " **REL** " button.
4. Connect the test leads across the capacitor to be measured.
5. Wait until the reading is stable, then read the reading on the display. (For high capacitance measurements, it may take about 30 seconds for the reading to stabilize.)

Note:

Before measurement, make sure that the capacitor to be measured has been discharged thoroughly.

Measuring Frequency and Duty Cycle

1. Connect the black test lead to the " **COM** " jack and the red test lead to the " **VΩHz** " jack.
2. Set the range switch to **Hz/%** position. Then press the " **Hz %** " button to select frequency measurement or duty cycle measurement, the display shows the corresponding unit.
3. Connect the test leads across the source or load to be

25

3. Connect the test leads to the circuit to be measured.
4. If the circuit resistance is less than about 30Ω , the built-in buzzer will sound.

Note:

To avoid electric shock to you or damage to the meter, disconnect circuit power and discharge all capacitors before continuity test.

Diode Test

1. Connect the black test lead to the " **COM** " jack and the red test lead to the " **VΩHz** " jack. (Note: The polarity of the red lead is positive " + " .)
2. Set the range switch to $\rightarrow+/•$ position, then press the " **S** " button until the symbol " $\rightarrow+$ " appears on the display.
3. Connect the red test lead to the anode of the diode to be tested, and the black test lead to the cathode.
4. Read the approximate forward voltage drop of the diode on the display.
If the connection is reversed, " OL " will be shown on the display.

24

measured.

4. Read the reading on the display.

Note:

1. For frequency measurements, the voltage of the input signal must be between 1V rms and 20V rms.
2. For duty cycle measurements, the voltage of the input signal must be between 3Vp-p and 10Vp-p.
If the frequency of input signal is too low, the reading's stability will decrease.
3. For both frequency and duty cycle measurements, if the voltage exceeds the specified range, the error of reading may be out of the specified accuracy range.

26

Automatic Power-Off

The display will blank and the meter will go into Sleep mode if you have not turned the rotary switch or pressed button for about 15 minutes. To arouse the meter from Sleep, just press a button.

To disable the automatic power-off feature, press and hold down a button while rotating the rotary switch from "OFF" position.

MAINTENANCE

Warning

Except replacing battery and fuse, never attempt to repair or service your meter unless you are qualified to do so and have the relevant calibration, performance test, and service instructions.

General Maintenance

Periodically wipe the case with a damp cloth and mild detergent. Do not use abrasives or solvents.

Dirt or moisture in the terminals can affect readings. Clean the terminals as follows:

27

This meter uses two fuses:

Fuse1 : F 400mA/690V, Min. Interrupt Rating 20000A, ø10X38mm

Fuse 2 : F 10A/690V, Min. Interrupt Rating 20000 A, ø10X38mm

To replace the fuse, remove the screws on the back cover and remove the back cover, replace the blown fuse with a new one of the same ratings. Reinstall the back cover and all the screws

ACCESSORIES

Manual: 1 piece

Test Lead: 1 pair

NOTE

1. This manual is subject to change without notice.
2. Our company will not take the other responsibilities for any loss.
3. The contents of this manual can not be used as the reason to use the meter for any special application.

29

1. Set the range switch to **OFF** position and remove the test leads from the meter.
2. Shake out any dirt which may exist in the terminals.
3. Soak a new swab with alcohol.
4. Work the swab around in each terminal.

Replacing the Battery and Fuse

Warning

To avoid false readings, which could lead to possible electric shock or personal injury, replace the battery as soon as the low battery indicator ("  ") appears.

To prevent damage or injury, install only replacement fuses with the specified amperage, voltage, and interrupt ratings.

Disconnect the test leads before opening the back cover or the battery cover.

To replace the battery, remove the screws on the battery cover and remove the battery cover, replace the exhausted battery with a new battery of the same type (9V, 6F22 or equivalent). Reinstall the battery cover and the screws.

28

DISPOSAL OF THIS ARTICLE

Dear Customer,
If you at some point intend to dispose of this article, then please keep in mind that many of its components consist of valuable materials, which can be recycled. Please do not discharge it in the garbage bin, but check with your local council for recycling facilities in your area.



30

V100614

